

**Solutions
for Silence**

We make the world a bit more quiet

PRODUCTS AND SERVICES

**RAIL DAMPERS
WHEEL DAMPERS
SHIMLIFT
RAILROAD SERVICES**



Schrey & Veit®

Noise, Shock & Vibration control



ABOUT US

Engineered in Germany - made in Germany – installed worldwide.

Schrey & Veit has been the leader in innovative noise and vibration mitigation solutions for the railway industry for 30 years. As a renowned family-owned business, we are proud to call ourselves the global market leader in this field. Our main products include rail damping systems which actively reduce noise emissions directly at the source, wheel damping systems specifically designed for high-speed trains and trams, as well as bridge dampers.

The rail dampers from S&V are not glued to the track. This makes installation and removal particularly easy and quick. They are maintenance-free, fire-resistant, and can be adapted to all rail profiles worldwide. Our products have received homologation for numerous

railway and subway networks around the globe.

With 30 years of experience in noise, shock, and vibration isolation, along with extensive expertise in acoustic studies, our team is committed to continuous research and development. Thanks to close partnerships with the railway industry, leading industrial partners, and prestigious academic institutions, we ensure that our products meet the highest quality standards.

At Schrey & Veit, we also offer a comprehensive range of services that includes detailed installation planning, technical support, and customized full-service packages on a global scale. Our unwavering commitment to working closely with our clients on their projects ensures personalized support and tailored solutions that exceed expectations.

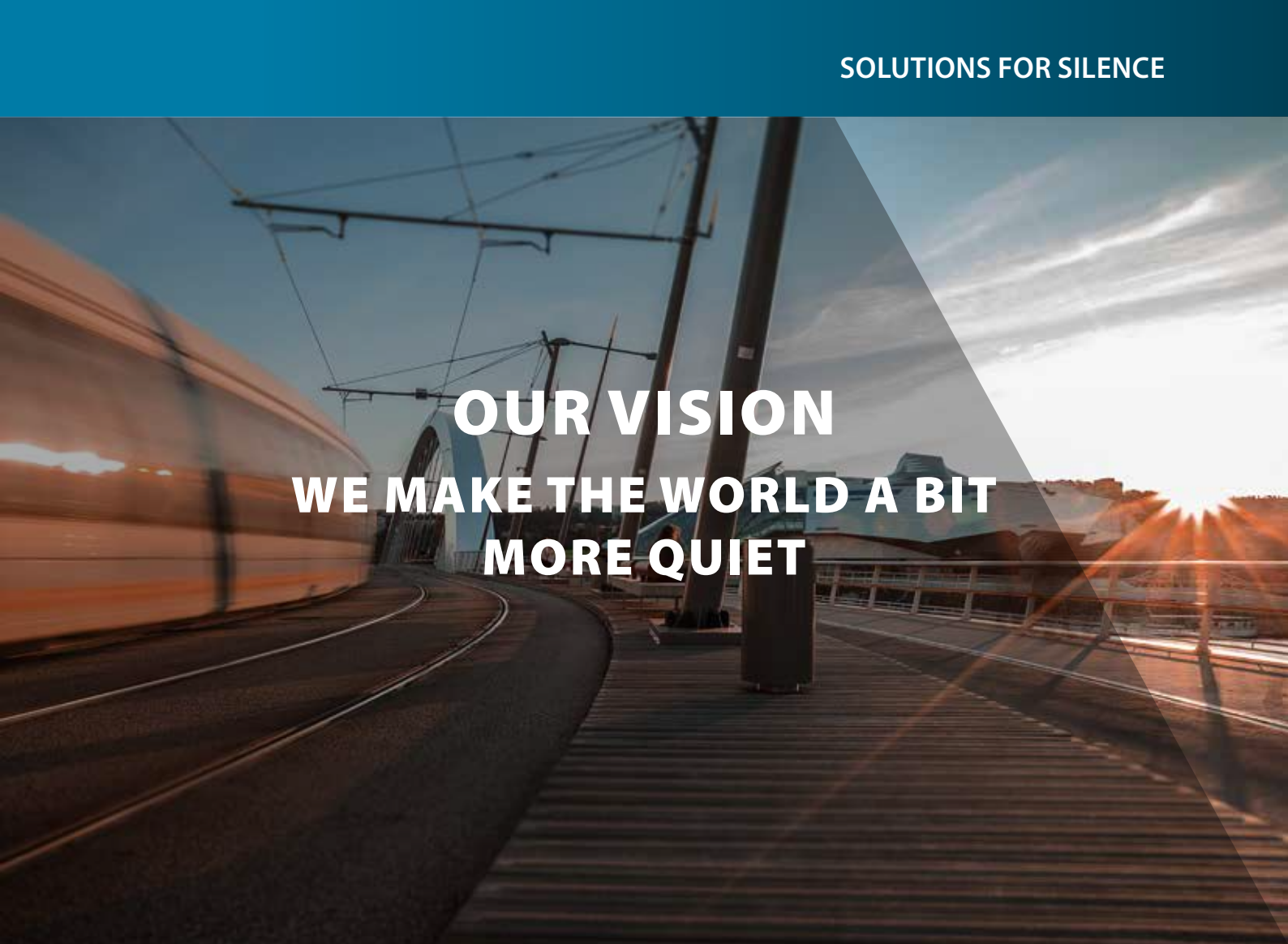

OUR VISION WE MAKE THE WORLD A BIT MORE QUIET

YEARS
RESEARCH AND
DEVELOPMENT

30

6

> 6 MIO INSTALLED
RAIL DAMPERSYSTEM
AROUND THE WORLD



> 40.000 INSTALLED
WHEEL DAMPERS

40

3

LOCATIONS
GERMANY, SWITZERLAND
AUSTRALIA

PROJECTS IN
COUNTRIES

24



CERTIFIED
ISO 9001:2015
TÜV DEKRA

BACKGROUND: THE SOURCE OF ROLLING NOISE

Railway noise is almost exclusively emitted by wheels and rails which are vibrating in specific resonances.

ACOUSTIC SOURCE TRACK

Rail dampers are installed in the sleeper bays – the section of the rail that executes the highest magnitude of vibration. Here, the damper effectively reduces rail vibration and consequently minimizes noise at its source.

By combination, selection and exchange of the metal and elastomer plates, both vertical and lateral vibrations can be finely tuned independently. The vibrational energy is then converted into thermal energy, ensuring efficient damping performance.

EXCITATION BY CORRUGATION

The roughness and corrugation on the rail not only induce vibrations but also generate noise. Grinding the rail is a well-known method to mitigate this issue. By incorporating rail dampers, the progression of corrugation can be effectively minimized, resulting in decreased maintenance expenses and lower noise emissions.

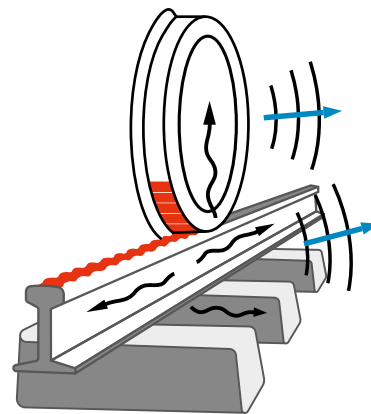
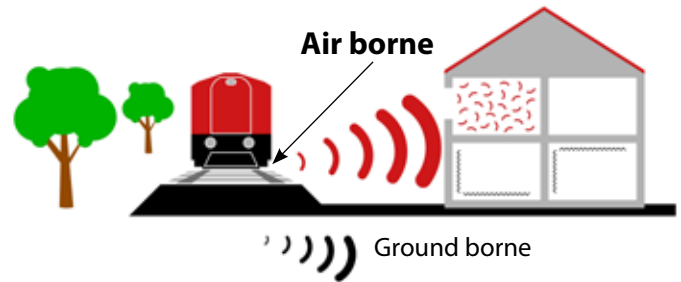

ACOUSTIC SOURCE WHEEL

Wheel dampers are fixed to those areas of the wheels which are vibrating with the highest magnitude. This reduces noise effectively directly at its origin.

The combination of metal and elastomer plates creates a counterforce that converts vibration into thermal energy, significantly diminishing noise levels.

WE MEASURE – WE TEST – WE DEVELOP



Schrey & Veit operates a globally unique R&D laboratory equipped with state-of-the-art testing devices to develop highly effective and efficient products. To find the best solution for your noise and vibration issues, we offer various measurements on rails, bridges, and railway wheels using both mobile and stationary testing devices, even if the components cannot be dismantled. Our in-house prototyping department can quickly and cost-effectively create customized test setups, ensuring the best possible results for you.



RAILROAD SERVICES

With a wealth of experience in railroad construction, Schrey & Veit is your trusted partner for the installation of our products. Whether you require new installations or maintenance services, we possess the expertise, specialized machinery, and equipment needed to deliver exceptional results. Our dedicated team works on-site to ensure a seamless, precise, and professional implementation process. For those who prefer to manage the installation independently, we also provide comprehensive professional training sessions.



**OUR PRODUCTION:
MADE IN GERMANY**

“Whether in production or on the tracks: Only 100% quality makes us satisfied. For 30 years.”

Simon Maurer / CTO



RAIL DAMPER

The rail damper is an innovative solution that leverages a mass spring system to effectively minimize rail noise. By targeting and mitigating the vibrations produced as trains traverse the tracks, the damper significantly reduces noise levels.

The rail damper is specially customized to suit various common rail types, ensuring seamless compatibility and optimal outcomes. Once the design for an individual rail damper is completed, it is tested, adjusted and optimized to ensure optimal acoustic performance. Through simulated train passage tests on the test stand, the tailored design of the rail dampers proves versatile for application on ballast or slab tracks across metro, conventional, or high-speed rail services.

ESPECIALLY FOR TRACK SECTIONS:

- » Where rolling noise dominates (in relation to traction or aerodynamic noise)
- » Where the track is less damped (low track decay rate in the relevant frequency band)
- » Where high noise screens are not possible or not welcome

NOISE REDUCTION:

Measurement results (examples)

Freight Train	approx. 3.5 dB
InterCity Train	approx. 4.5 dB
Regio Train	approx. 4.5 dB
Metro (interior)	up to 15dB

USPs: MAIN ADVANTAGES OF SCHREY & VEIT RAIL DAMPERS

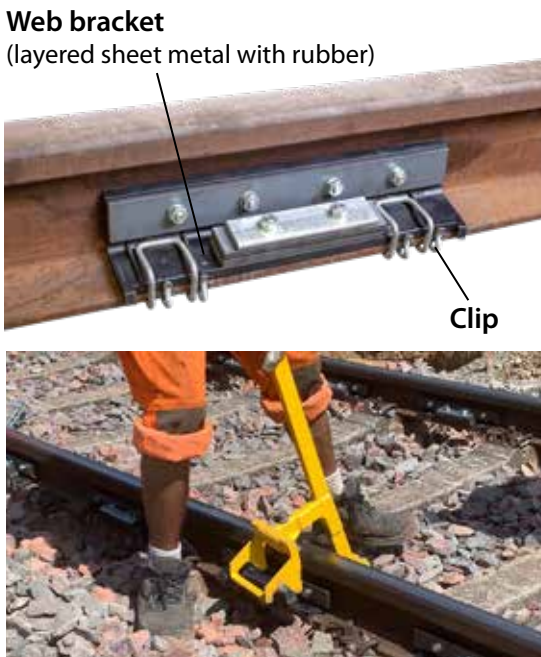
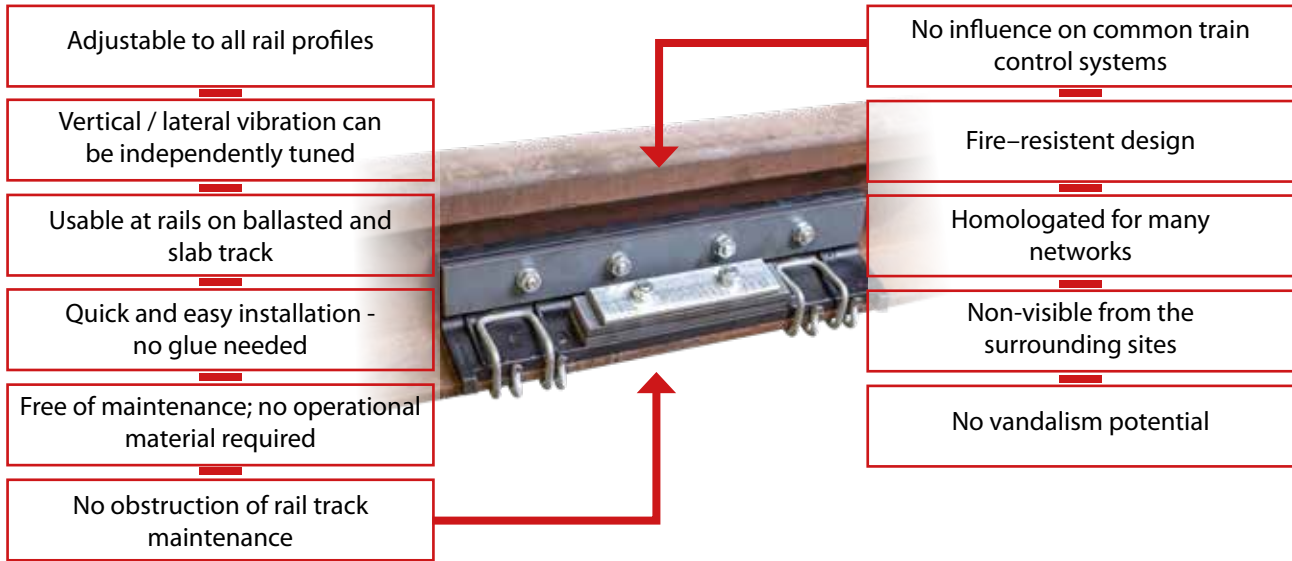

EASY INSTALLATION

Installing rail dampers on existing tracks requires minimal preparation work, streamlining the installation process and reducing time requirements. Only a small amount of ballast beneath the rail foot needs to be removed, a task easily accomplished using a ballast pusher operated by a standard two-way excavator. The dampers are conveniently stored on a railroad transport unit for efficient distribution, which is then pulled by an excavator to initiate installation immediately after ballast removal.

The rail damper installation itself is straightforward, utilizing a simple hand-held tool for attachment to the rail with thermally treated high-performance clips. Thanks to the exclusion of any adhesive, sealants, or contact paste, disassembling and reassembling the rail dampers (e.g., during rail changes) is a swift and easy process. The high-performance clips are designed for multiple reuses, further enhancing efficiency and cost-effectiveness.

DAMPER AND TRACK MAINTANANCE

Our rail dampers are fully compliant with essential track maintenance processes such as rail grinding, rail milling, ballast tamping, and rail fastening replacement without any hindrance. Crafted from highly heat-resistant materials, the components of the rail damper remain in place during rail grinding operations, eliminating the need for removal.

The damper is maintenance free under common railway conditions. The design characteristics ensure a long service life. In the event of rail replacement requirements, the dampers can be effortlessly uninstalled and stored adjacent to the rail until reinstallation using the same tool and clip system.



„Worldwide measurements on various tracks show considerable reduction in rolling noise.“



WHEEL DAMPERS

Both rolling noise and curve squealing are emitted by wheel vibrations induced from rolling on the track.

Schrey & Veit offers vibration dampers for wheels, targeting areas of highest vibration occurrence. Our wheel dampers provide an acoustic energy absorption, effectively reducing vibrations and thus noise emissions.

The VICON RASA wheel dampers consist of a combination of metal and elastomer plates, which create a counterforce to the wheel vibrations based on the mass-spring principle. The vibration energy its amount is very small and seamlessly dispersed and absorbed by the wheel. The absorber's durability ensures a rolling' and squealing noise reduction throughout the wheel's entire lifespan. These maintenance-free systems serve as a sustainable alternative to traditional rail lubrication methods. Furthermore, the wheel absorbers are designed for reusability on new wheels until they reach their wear limit, offering a cost-effective and efficient solution for noise reduction.

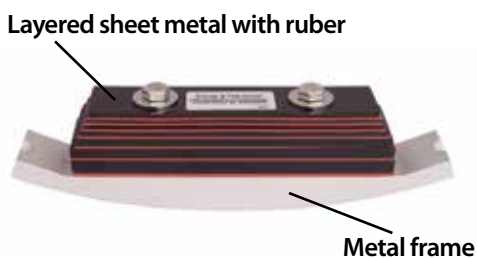

USPs: WHEEL DAMPER A CORE COMPETENCE OF SCHREY & VEIT

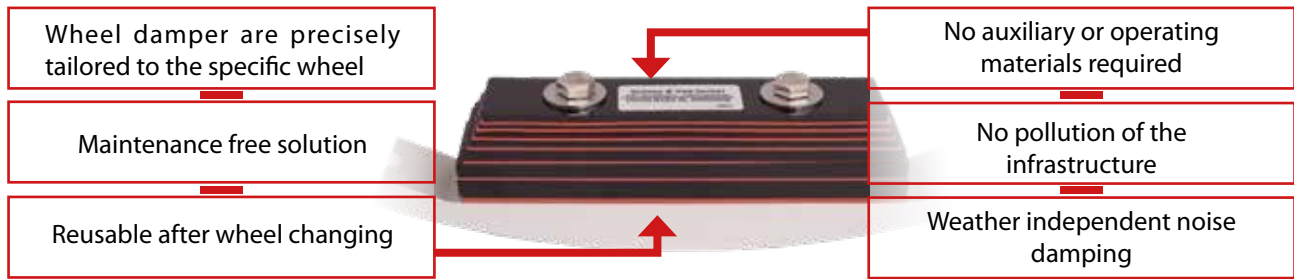

WHEEL DAMPERS ARE INDIVIDUALLY DESIGNED AND TUNED

The sound radiation from railway wheels occurs predominantly in their resonance frequency ranges. Wheel dampers are constructed as multi-layer resonators where single metal plates are followed by layers of elastomers.

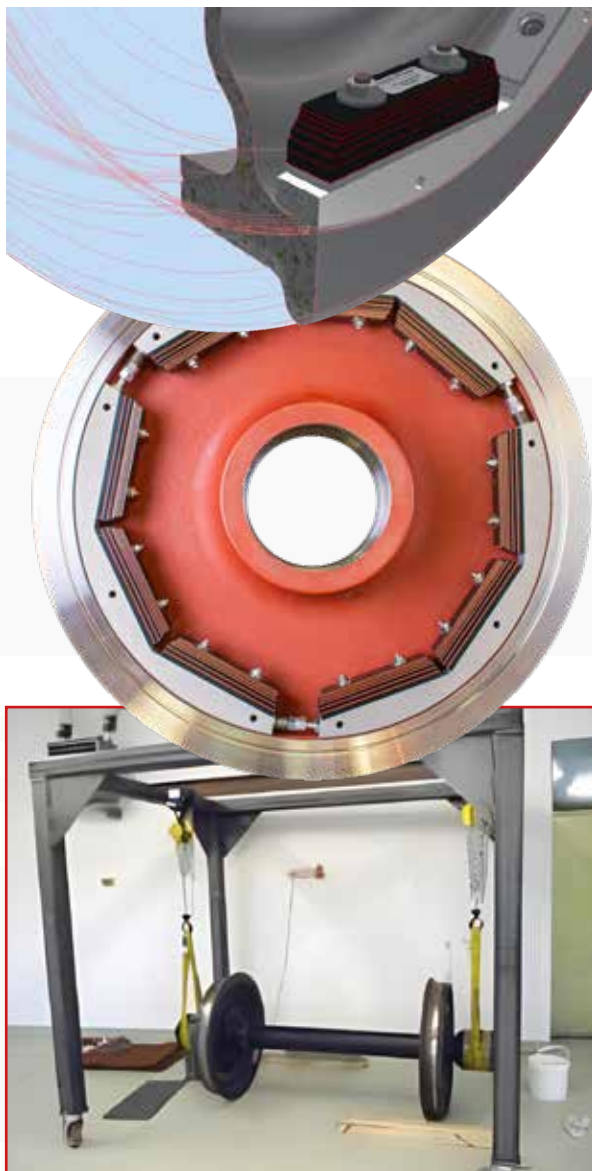

We design according to long-term expertise:

- » Due to the different wheel designs and installing possibilities, we consider the designs, quantities and fixation approaches.
- » We tune the damper to target the specific wheel noise frequencies and to achieve the maximum noise reduction.
- » We offer different designs that allow both radial and axial fixations on the wheels.
- » The final wheel damper delivers a broad-band vibration reduction and maintains consistent damping properties until the wheel reaches its wear limit.



SHIMLIFT

ShimLift is a height-adjustable rail fastening system that improves track positioning in challenging areas. The innovative measure reduces maintenance costs significantly.

Application examples:

- › In front of and behind railroad bridges
- › In front of and behind level crossings
- › Transition zones from ballasted to slab track
- › At insulated rail joints (IRJ's)

ShimLift Installation:

- › No processing of the ballast bed required
- › Replacement of the rail fastening by ShimLift, dismantled rail fastening can be reused
- › Installation per transition zone: 3-4 man hours per 10 sleepers
- › Readjustment per transition zone: 1.5 man hours per 10 sleepers

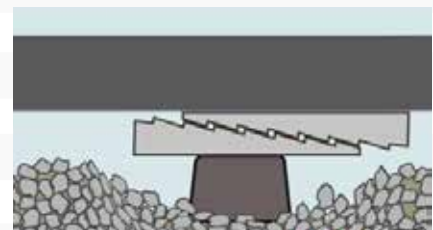

ShimLift Approvals:

- › EBA approval (DB)
- › User approval (DB)
- › Approval Prorail (NL)
- › Approval Infrabell (B)

USPs: SHIMLIFT HEIGHT LEVELING FASTENER

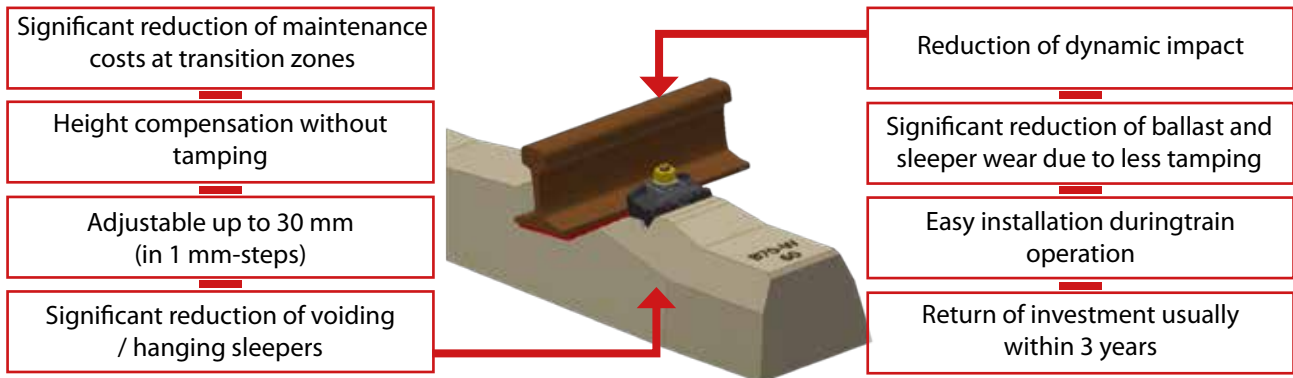

THE BALLAST MEMORY EFFECT

The ballast needs sufficient space to form a new load-bearing and stable layer after maintenance tamping. When removing hollow layers by tamping, usually only the angular position of the ballast stones under the sleepers is changed, but not their orientation, and no new stones are added. This prevents the formation of a stable track bed: after just a few train passes, the ballast stones return to their original position. From that, the effect is lost, wear is back – the “memory effect” takes place.

TRANSITION ZONES

Transition zones are the track section between open track and slab track. These transition zones are found at the front of and behind railroad bridges as well as level crossings and where a ballast superstructure changes to slab track. Transition zones can also occur in the areas of different ballast qualities (e.g. transition from old ballast to new ballast).

These sections are challenging due to the different settlement amounts from the track structures which have to be long-lasting neutralized.

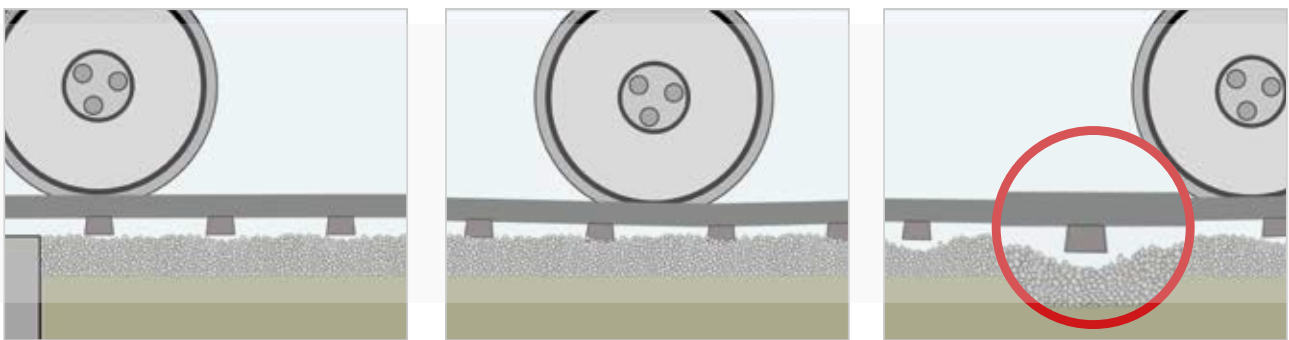

Strong rail movement without ShimLift (graphical representation)

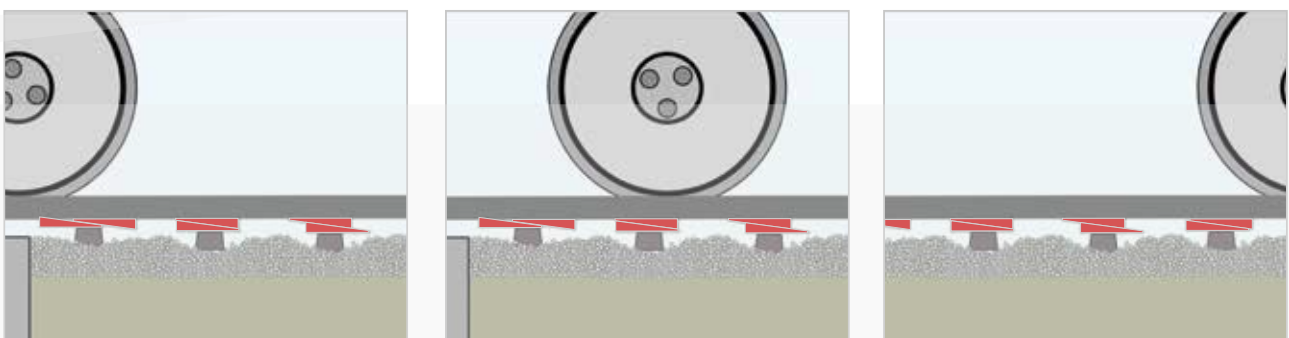

Low rail movement with ShimLift (graphical representation)



BRIDGE DAMPERS

Steel railroad bridges present a unique challenge in noise reduction due to their low inherent damping, resulting in pronounced sound radiation that significantly impacts both people and the environment.

On standard tracks, sound emissions from moving trains originate from three main components: rail, wheel and corrugation. However, on steel bridges without a ballast bed, the bridge structure itself becomes an additional source of noise. This causes the sound spectrum of bridge crossings to shift toward lower frequencies, leading to the phenomenon known

as “bridge roaring.” This structure-borne noise can more than double the noise emissions of rail traffic.

To mitigate this issue, bridge absorbers, consisting of numerous vibrating metal tongues, are employed. These absorbers are mounted on the bridge’s longitudinal and transverse girders, and sometimes extended to the deck plates. The reduction in bridge noise typically occurs in frequencies ranging from 20 to 150 Hz.

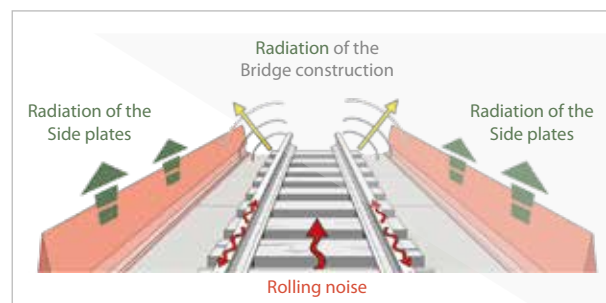

USPs: BRIDGE DAMPER - SUCCESS AGAINST NOISE FROM BRIDGES

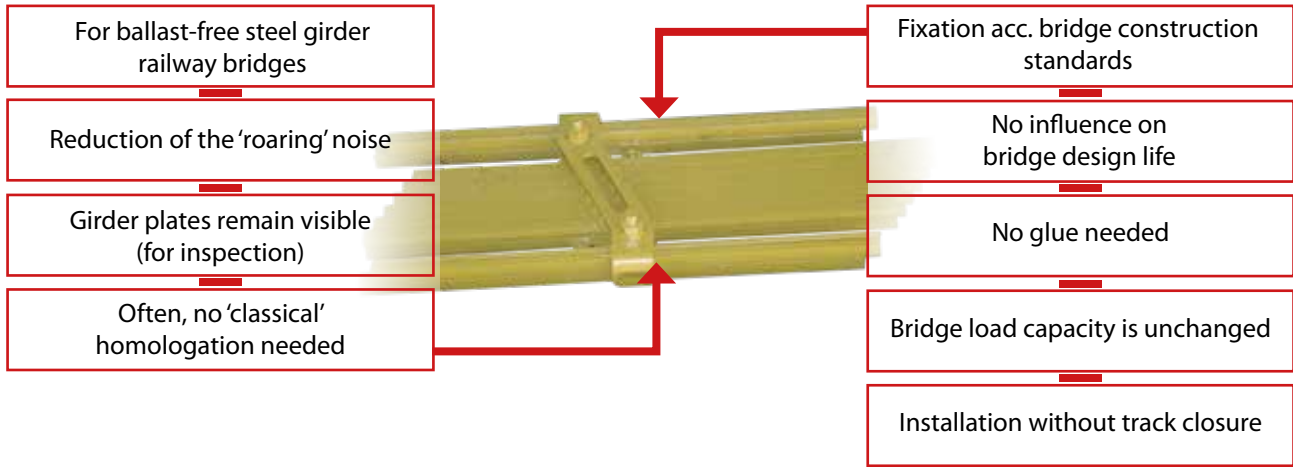

Effective noise reduction hinges on precisely matching absorbers to the unique vibration characteristics of each bridge.

To achieve optimal results across various train types and speeds, detailed measurements are conducted on the bridge during train crossings. These data are then used to fine-tune the absorbers through FEM (Finite Element Method) analysis on a computer.

The installation of bridge absorbers is carried out without track closure, if the bridge structure can be reached from the area underneath the bridge (via scissor lift etc.). Also, the vibration measurement for tuning the dampers, is only leading to a short-time single track closure. This is also necessary when the bridge cannot be reached from the underside. Maximizing the reduction of bridge noise can be further supported by complementary measures, such as decoupling the rail from the guideway, utilizing specialized intermediate layers, and, if necessary, installing rail dampers.



Measurements on more than 15 bridges showed an average reduction of the sound pressure level of 3 dB - 6 dB(A).

FROM CONCEPT TO INSTALLATION: YOUR PROJECT IN EXPERT HANDS



FULL-SERVICE EXPERTISE ALL IN ONE

We offer comprehensive guidance and take full responsibility for the entire process, from initial conception and planning through to installation. With our expertise, we ensure the smooth and professional organization and coordination of your railway project, whether it involves rail or wheel dampers, or ShimLift. Whether you're embarking on a new installation or undertaking maintenance, we have the precise knowledge and specialized equipment to meet your needs. Our services are tailored to your requirements, providing you with a complete, worry-free package.



EXPERIENCE AND FLEXIBILITY

With nearly 30 years of experience in researching dampening systems, we are proud to be the international leading experts in noise mitigation for rails and wheels. Our expertise is second to none, and we are eager to put it to work for you.

We offer exceptional flexibility in both implementation and adjustment, even during the execution of ongoing projects. Our close partnership with clients ensures rapid response times, and we are always ready to go the extra mile to guarantee the success of your project.



QUALITY AND RELIABILITY

We stand fully behind our products. Every aspect of our design and production is meticulously overseen, with our laboratory and manufacturing facilities located side by side.

We source components exclusively from trusted partners whose quality we can vouch for. And whenever you have questions, you can count on us for prompt, reliable, and expert support.



WE ARE CERTIFIED

With us, you receive not only certified products, but also project implementation that adheres to the highest standards, guidelines, and regulations.

Our team is trained in railway operations, and we ensure quality assurance by providing certification for installation documentation and maintaining comprehensive records.

**SCHREY & VEIT GMBH –
YOUR SERVICE PROVIDER FOR ALL ASPECTS
OF INSTALLATION OF RAIL DAMPING SYSTEMS
AND SPECIAL RAIL FASTENERS**

WE ARE THE GLOBAL MARKET LEADER
CUSTOMERS AND PARTNERS



“ Customer satisfaction regarding quality and reliability of our products and services is of the utmost importance to us.
Karl Schneider / CEO

CONTACT US AND TELL US ABOUT YOUR PROJECT!

Schrey & Veit GmbH

Graf-von-Sponheim-Str. 2 | 55576 Sprendlingen | GERMANY | Fon +49 (0) 6701 205 84 0 | E-Mail: info@sundv.de



**We make the world a
bit more quiet**



Schrey & Veit®

Noise, Shock & Vibration control

Schrey & Veit GmbH

Graf-von-Sponheim-Str. 2 | 55576 Sprendlingen | GERMANY

Fon +49 (0) 6701 205 84 0 | Fax +49 (0) 6701 205 84-10

www.sundv.de